

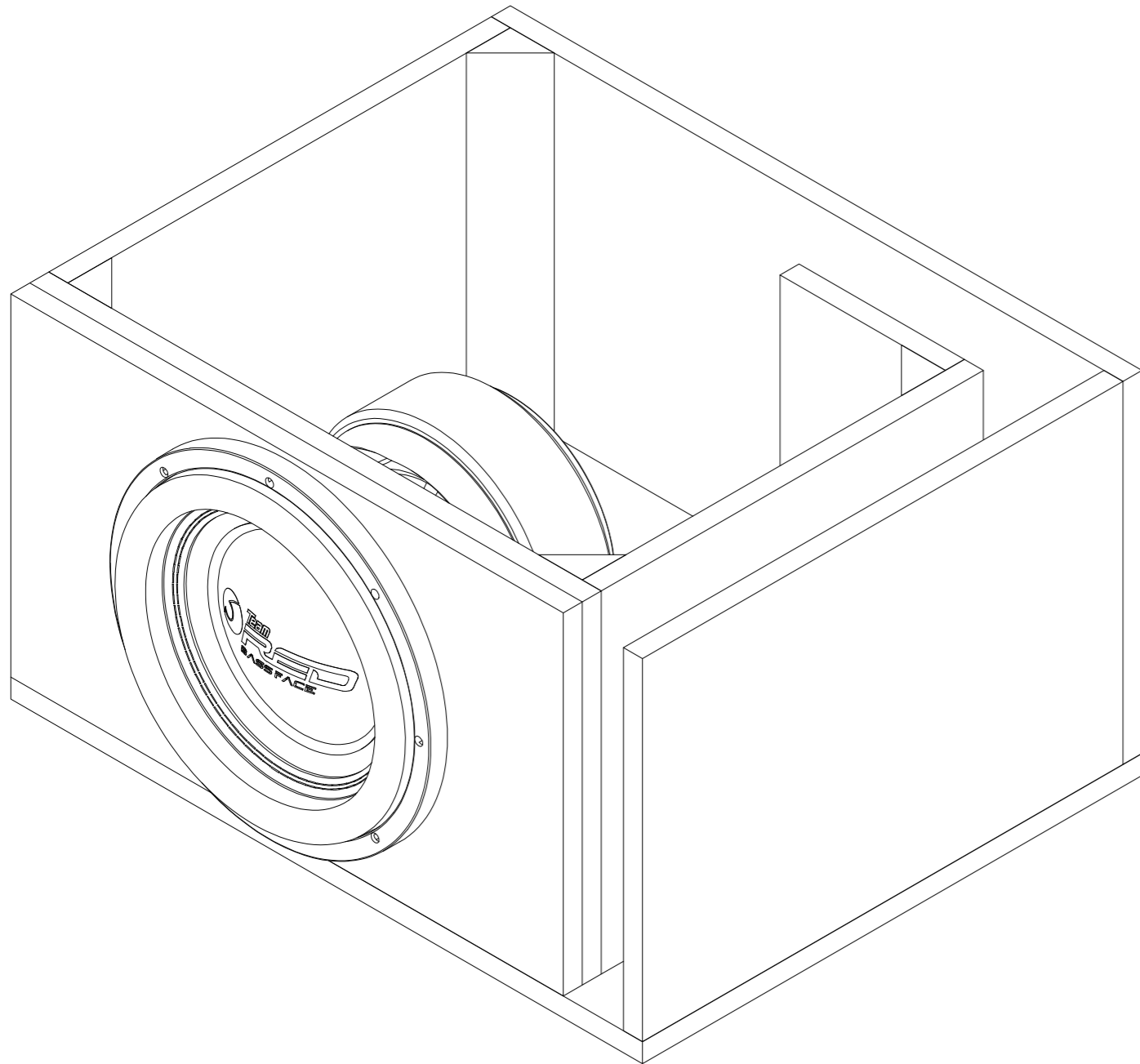

BASSFACE

TEAM RED 12 VENTED ENCLOSURE PROJECT



*All joints glued and screwed.

*Use Phenolic plywood or MDF.

*Seal all joint lines before use with silicone.

*Do not secure the woofer with self tapping screws. Use T nuts or captive nuts.

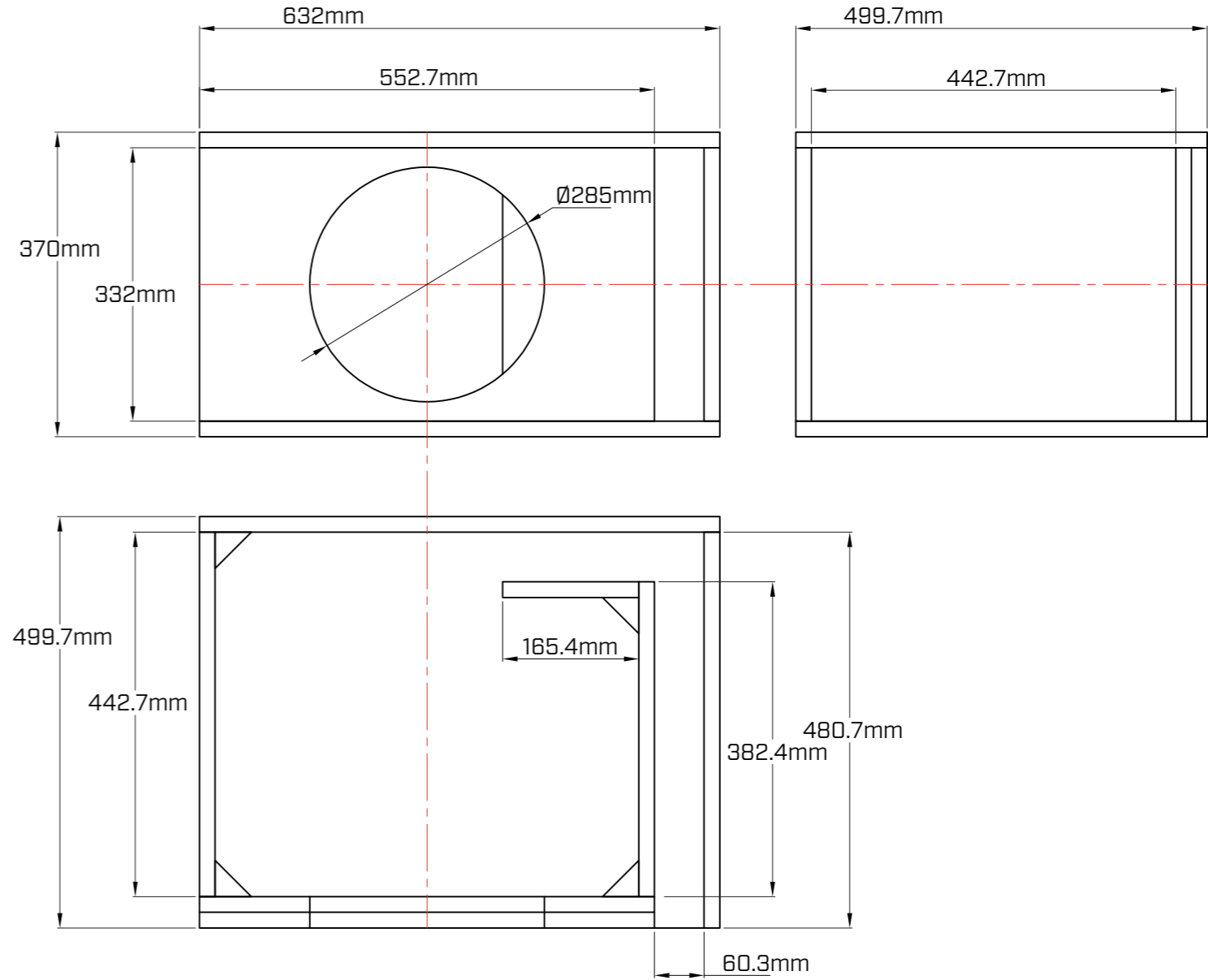

Parameter	Value	
Box External Dimension (W*H*D)	632*370*499.7 mm	
Material Thickness	19 mm	
Net Internal Volume	70 L	
Turning Frequency	32 Hz	
Port Area	220 cm ²	
Port Inlet (W*H)	60.3*332mm	
Port Length	665.1mm	
Details	Size	Quantity
Top/Bottom	632*499.7 mm	2
Front	552.7*332 mm	1
Rear	632*332 mm	1
Left	442.7*332 mm	1
Right	480.7*332 mm	1
Port	382.4*332 mm	1
Port	165.4*332 mm	1
Triangulation Plate	44*44*62.23*332 mm	4